

SPECIAL APPLICATION DIES

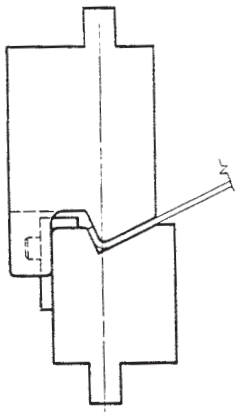

SET 189



SET 190

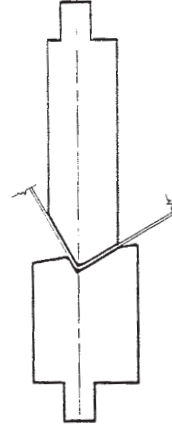

SET 191

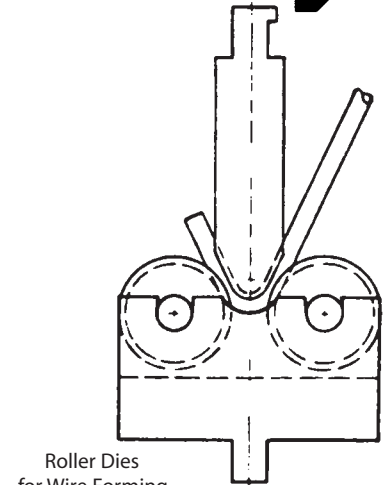

Roller Dies
for Wire Forming

SET 204

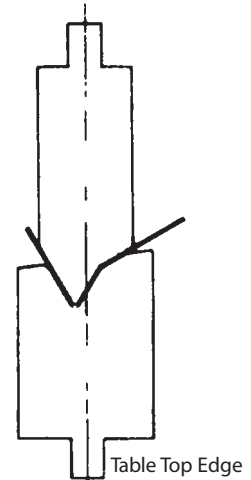
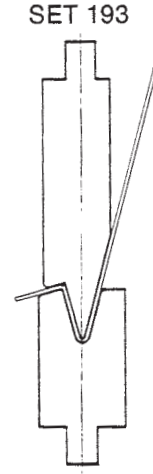
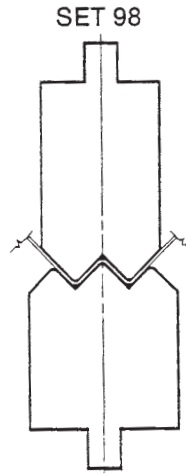
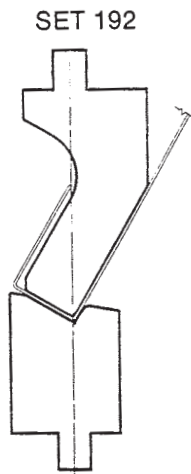
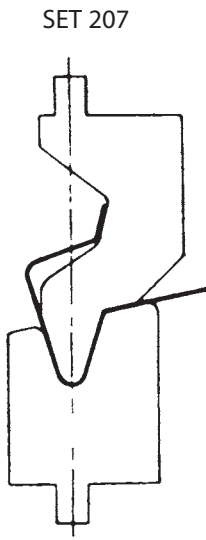
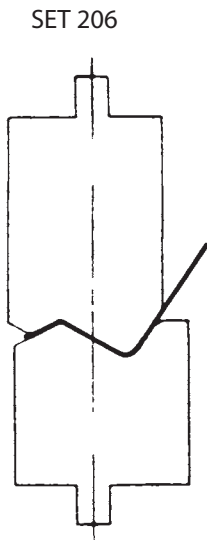
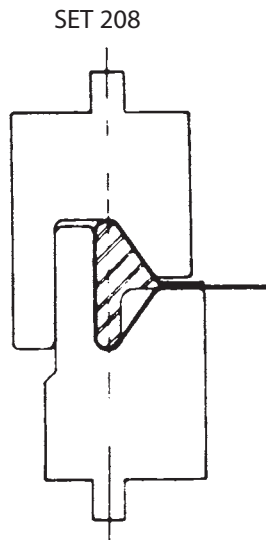

Table Top Edge
SET 205



Edge Reinforcement



Edge Reinforcement

